

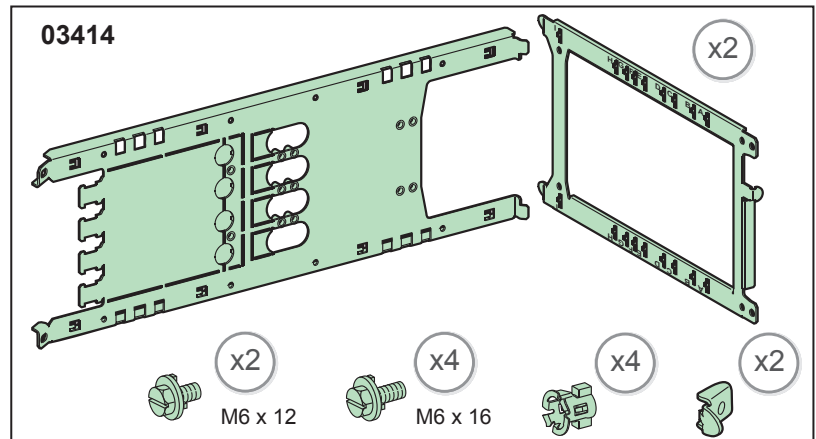

en fr es de it pt zh ru

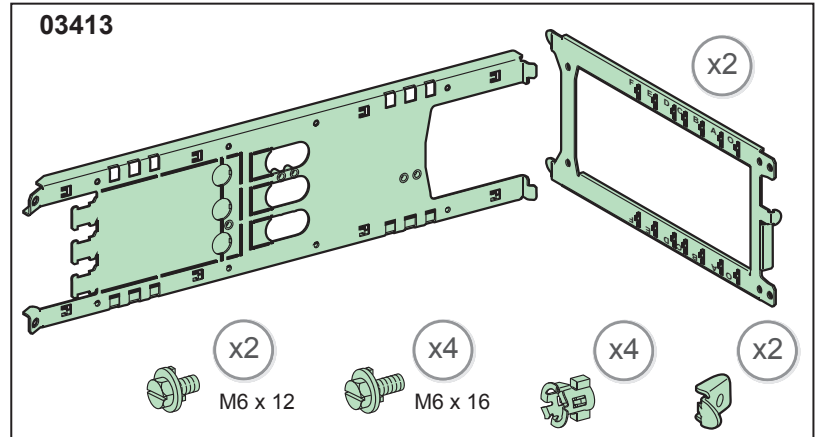
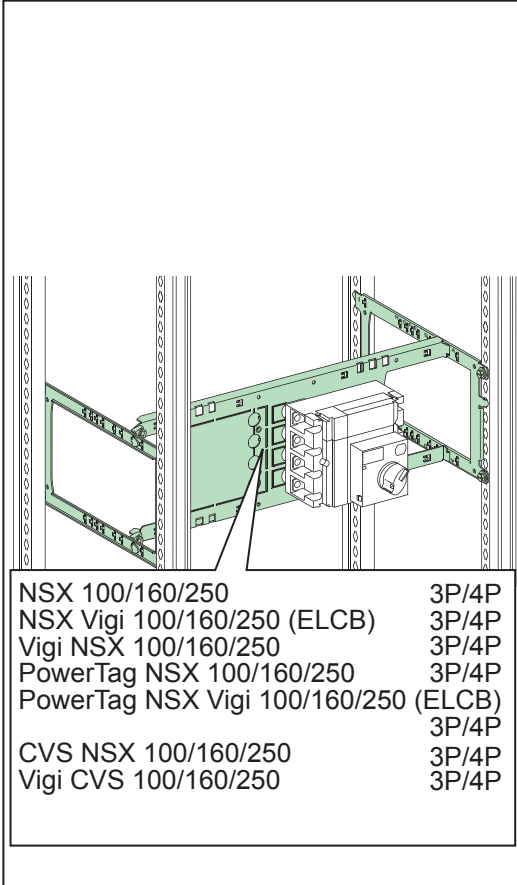

<p>PLEASE NOTE Electrical equipment should be installed, operated, serviced, and maintained only by qualified personnel. No responsibility is assumed by Schneider Electric for any consequences arising out of the use of this material.</p>	<p>REMARQUE IMPORTANTE L'installation, l'utilisation, la réparation et la maintenance des équipements électriques doivent être assurées uniquement par du personnel qualifié. Schneider Electric décline toute responsabilité quant aux conséquences de l'utilisation de ce matériel.</p>	<p>TENGA EN CUENTA La instalación, manejo, puesta en servicio y mantenimiento de equipos eléctricos deberán ser realizados sólo por personal cualificado. Schneider Electric no se hace responsable de ninguna de las consecuencias del uso de este material.</p>	<p>BITTE BEACHTEN Elektrische Geräte dürfen nur von Fachpersonal installiert, betrieben, bedient und gewartet werden. Schneider Electric haftet nicht für Schäden, die durch die Verwendung dieses Materials entstehen.</p>
<p>NOTA Manutenzione, riparazione, installazione e uso delle apparecchiature elettriche si devono affidare solo a personale qualificato. Schneider Electric non si assume alcuna responsabilità per qualsiasi conseguenza derivante dall'uso di questo materiale.</p>	<p>NOTA A instalação, utilização e manutenção do equipamento eléctrico devem ser efectuadas exclusivamente por pessoal qualificado. A Schneider Electric não assume qualquer responsabilidade pelas consequências resultantes da utilização deste material.</p>	<p>请注意 电气设备的安装、操作、维修和维护工作仅限于合格人员执行。Schneider Electric 不承担由于使用本资料所引起的任何后果。</p>	<p>ОБРАТИТЕ ВНИМАНИЕ Установка, эксплуатация, ремонт и обслуживание электрического оборудования может выполняться только квалифицированными электриками. Компания Schneider Electric не несет никакой ответственности за любые возможные последствия использования данной документации.</p>

A

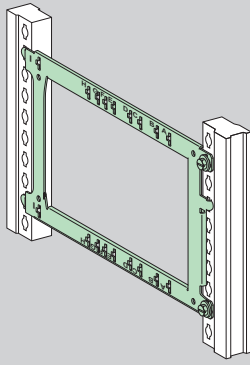

1

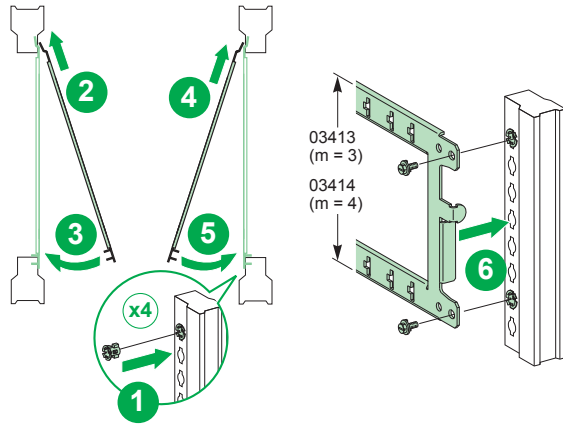

B

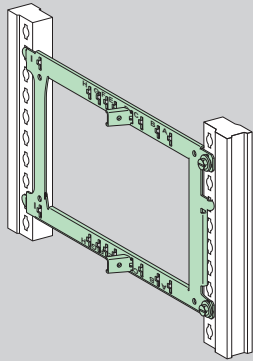

i

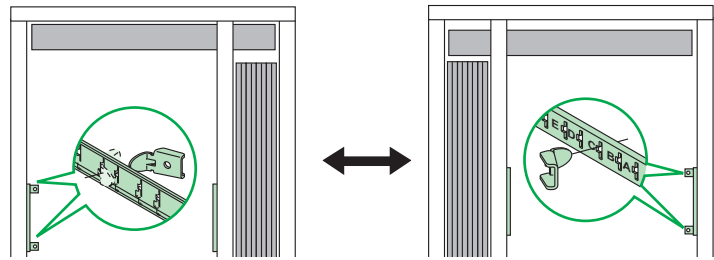

1

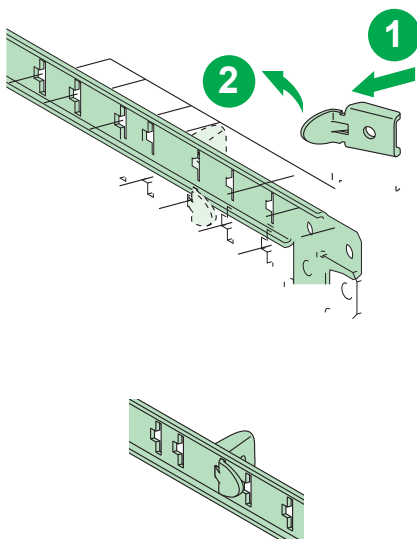

i

03413

NSX 100/160/250	3P
NSX Vigi 100/160/250 (ELCB)	3P
Vigi NSX 100/160/250	3P
CVS 100/160/250	3P
Vigi CVS 100/160/250	3P

A B D

NSX 100/160/250	3P
NSX Vigi 100/160/250 (ELCB)	3P
Vigi NSX 100/160/250	3P
CVS 100/160/250	3P
Vigi CVS 100/160/250	3P

D E F

PowerTag NSX 100/160/250	3P
PowerTag NSX Vigi 100/160/250 (ELCB)	3P

B

03414

NSX 100/160/250	4P
NSX Vigi 100/160/250 (ELCB)	4P
Vigi NSX 100/160/250	4P
CVS 100/160/250	4P
Vigi CVS 100/160/250	4P



A B D

NSX 100/160/250	4P
NSX Vigi 100/160/250 (ELCB)	4P
Vigi NSX 100/160/250	4P
CVS 100/160/250	4P
Vigi CVS 100/160/250	4P

D E G

PowerTag NSX 100/160/250	4P
PowerTag NSX Vigi 100/160/250 (ELCB)	4P

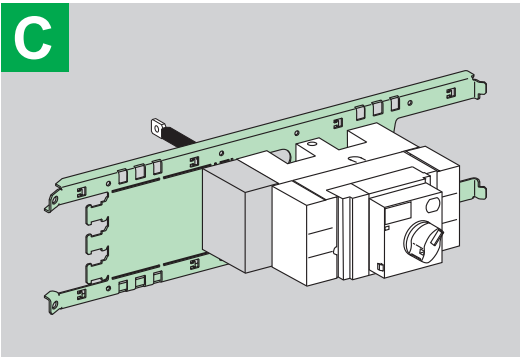
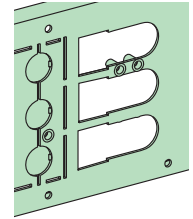
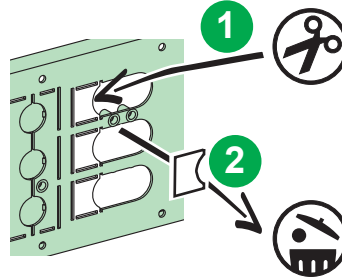
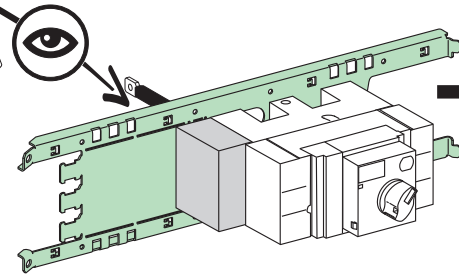
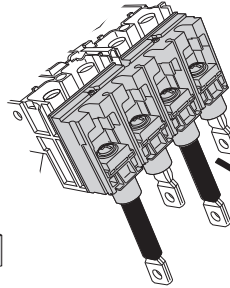
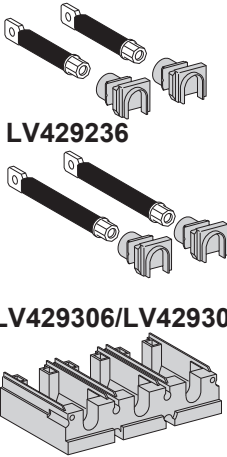
B

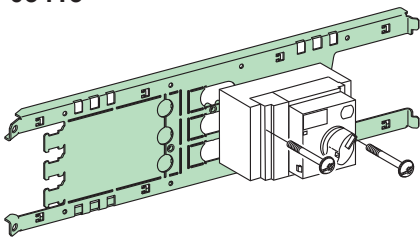
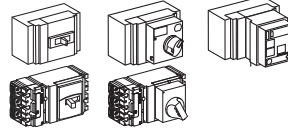
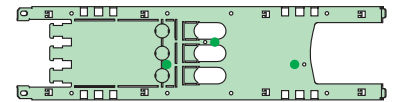
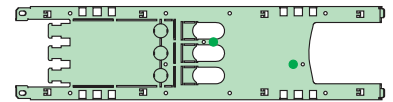
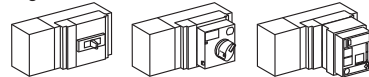
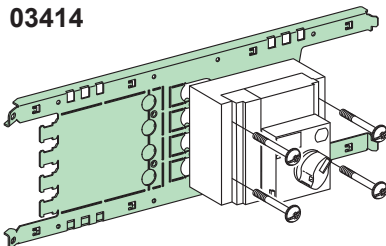
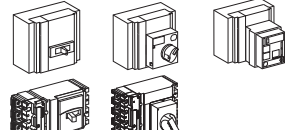
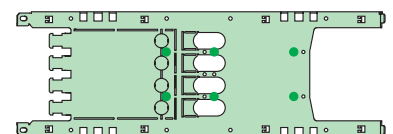
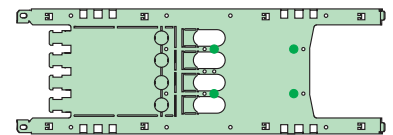
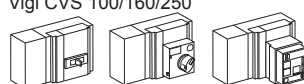
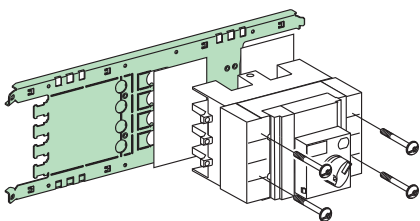
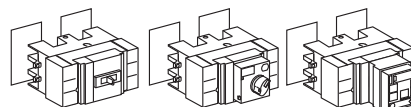
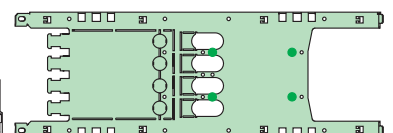
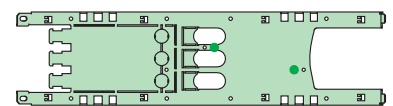
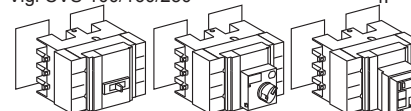
C**1****LV429235 + LV429236 + LV429306****i****LV429235****LV429236****LV429306/LV429307**NSX 100/160/250 3P
CVS 100/160/250 3P
 LV429235 +
LV429236 + LV429306
NSX 100/160/250 4P
CVS 100/160/250 4P
 LV429235 +
LV429236 + LV429307
i**03413**NSX 100/160/250 3P
NSX Vigi 100/160/250 (ELCB) 3P
PowerTag NSX 100/160/250 3P
PowerTag NSX Vigi 100/160/250 (ELCB) 3P
CVS 100/160/250Vigi NSX 100/160/250 3P
Vigi CVS 100/160/250 3P**03414**NSX 100/160/250 4P
NSX Vigi 100/160/250 (ELCB) 4P
PowerTag NSX 100/160/250 4P
PowerTag NSX Vigi 100/160/250 (ELCB) 4P
CVS 100/160/250 4PVigi NSX 100/160/250 4P
Vigi CVS 100/160/250 4P**03413****03414**NSX 100/160/250 3P
NSX Vigi 100/160/250 (ELCB) 3P
CVS 100/160/250 3PVigi NSX 100/160/250 4P
Vigi CVS 100/160/250 4P

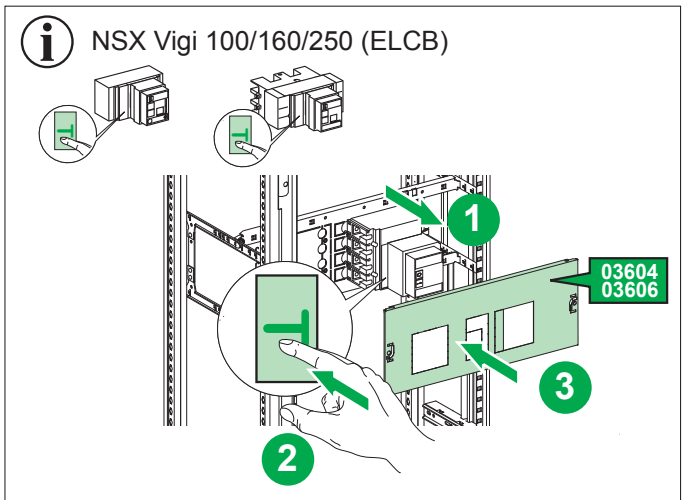
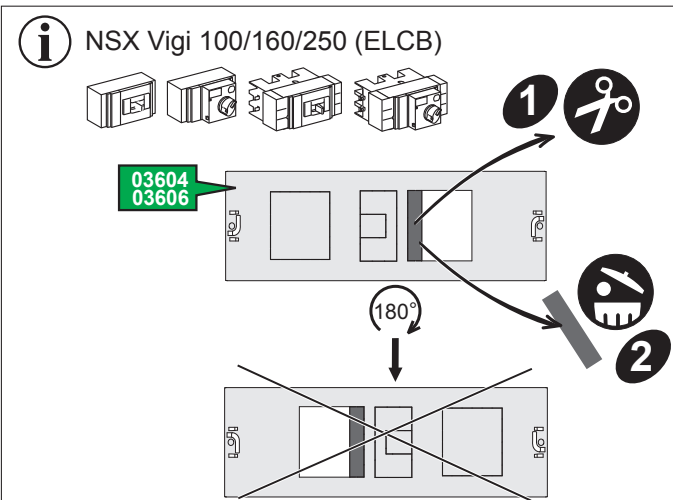
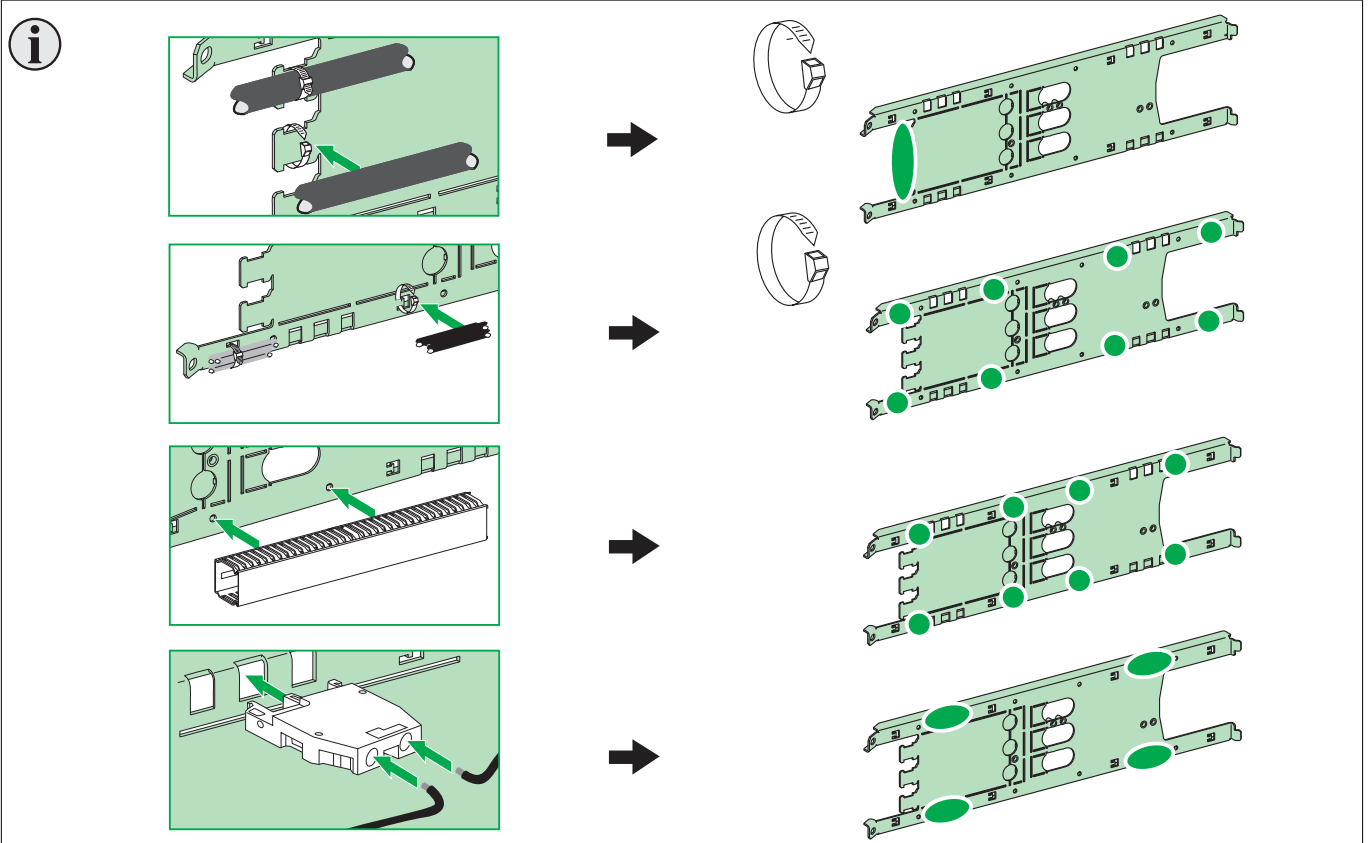
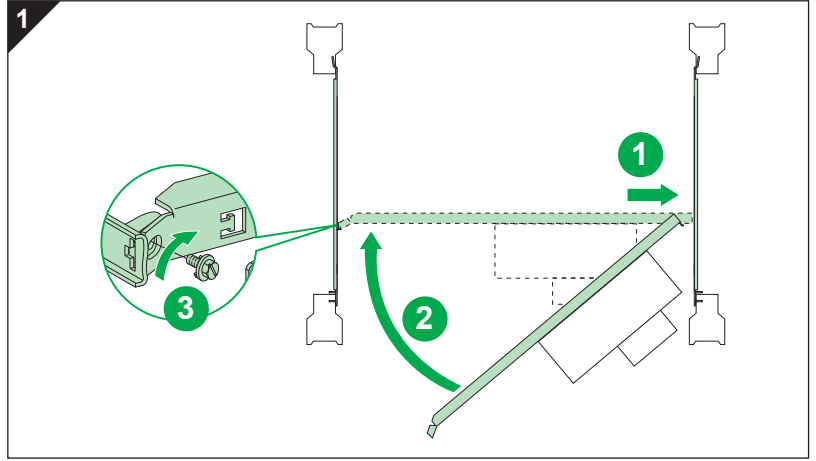
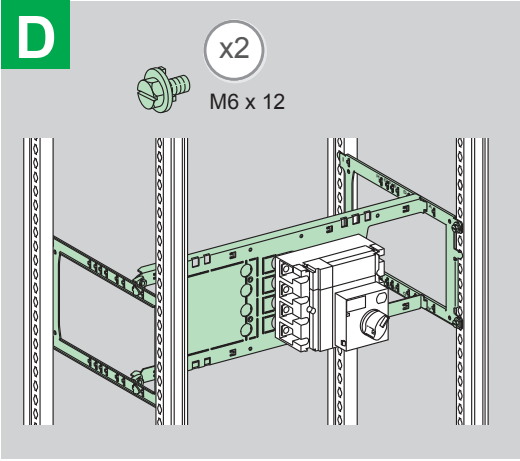

Schneider Electric Industries SAS
35, rue Joseph Monier
92506 Rueil Malmaison
France

<http://www.schneider-electric.com>

04696005AF - 00

En raison de l'évolution des normes et du matériel, les caractéristiques indiquées par le texte et les images de ce document ne nous engagent qu'après confirmation par nos services.

As standards, specifications and designs change from time to time, please ask for confirmation of the information given in this publication.

Publication : Schneider Electric
Réalisation : Schneider Electric
Impression :
Format de pliage : 210 x 148.5 mm

© 2018 Schneider Electric - All rights reserved.



Ce document a été imprimé sur du papier écologique.
This document has been printed on ecological paper.

02/2018